



ETA-Danmark A/S
Kollegievej 6
DK-2920 Charlottenlund
Tel. +45 72 24 59 00
Fax +45 72 24 59 04
Internet www.etadanmark.dk

Authorised and notified according
to Article 29 of the Regulation (EU)
No 305/2011 of the European
Parliament and of the Council of 9
March 2011

MEMBER OF EOTA



European Technical Assessment ETA-14/0114 of 02/06/2014

General Part

Technical Assessment Body issuing the ETA and designated according to Article 29 of the Regulation (EU) No 305/2011: ETA-Danmark A/S

Trade name of the
construction product:

MERK Timber post bases

Product family to which the
above construction product
belongs:

Three-dimensional nailing plate (Post bases for the
support of timber columns and posts as load-bearing
elements)

Manufacturer:

MERK Timber GmbH
Industriestraße 2
D – 86551 Aichach
Tel. +49 8251 908-0
Fax +49 8251 908-999
Internet www.merk.de

Manufacturing plant:

MERK Timber GmbH
Industriestraße 2
D – 86551 Aichach

This European Technical
Assessment contains:

31 pages including 4 annexes which form an integral
part of the document

This European Technical
Assessment is issued in
accordance with Regulation
(EU) No 305/2011, on the
basis of:

Guideline for European Technical Approval (ETAG)
No. 015 Three Dimensional Nailing Plates, April
2013, used as European Assessment Document
(EAD).

This version replaces:

-

Translations of this European Technical Assessment in other languages shall fully correspond to the original issued document and should be identified as such.

Communication of this European Technical Assessment, including transmission by electronic means, shall be in full (excepted the confidential Annex(es) referred to above). However, partial reproduction may be made, with the written consent of the issuing Technical Assessment Body. Any partial reproduction has to be identified as such

II SPECIFIC PART OF THE EUROPEAN TECHNICAL ASSESSMENT

1 Technical description of product and intended use

Technical description of the product

The post bases are made of 8 to 12 mm thick steel plates in combination with steel tubes, threaded rods, dowels and/or self-tapping screws. The post bases are produced from steel grade S235JR according to EN 10025-2 with minimum characteristic yield strength of $R_{eH} = 235 \text{ N/mm}^2$ and a minimum characteristic tensile strength of $R_m = 360 \text{ N/mm}^2$. The threaded rods correspond to property class 4.6 according to EN 1993-1-8.

For the connections with metal fasteners dowels $\varnothing 10 \text{ mm}$ (S235) and self-tapping screws $\varnothing 5 \times 70 \text{ mm}$ and $\varnothing 8 \times 160 \text{ mm}$ according to ETA 12/0114 are used.

All steel elements are zinc coated by hot-dip galvanizing with minimum thickness of $25 \mu\text{m}$ which is in agreement with the required classes Fe/Zn 25c and Z350 (according to EN 10346) in Eurocode 5.

The wood screws shall be in accordance with ETA for self-tapping screws no. ETA-12/0114.

Dimensions and product specifications are given in Annex A and Annex B.

2 Specification of the intended use in accordance with the applicable EAD

The intended use of the post bases is the support of timber columns and posts as load-bearing elements, where requirements for mechanical resistance and stability and safety in use in the sense of the Basic Work Requirements 1 and 4 of the Regulation 305/2011 (EU) shall be fulfilled.

The timber posts may be of solid timber of minimum strength class C24 according to EN 338 or of glued laminated timber of minimum strength class GL24h according to EN 14080. Minimum dimensions for the post have to be considered (Annex B).

The post base shall be installed as pictured in the drawings. The cross-section of the timber column shall be positioned centrally and with the end grain plane on the base plate.

The maximum distance between the foundation and the base plate of the post base is given in Annex B.

Annex D states the load-carrying capacities of the post bases. The design of the connections shall be in accordance with Eurocode 3 and Eurocode 5 or a similar national code. The

anchorage of the post base in the foundation and imperfections exceeding the assumptions in Eurocode 5, 5.4.4 are not part of this ETA.

For the clamped (fixed) types of post bases the anchorage in the concrete foundation are included in Annex D. The concrete shall be in accordance with strength class C20/25 according to Eurocode 2-1-1 or better.

For the anchorage of the other post bases in the concrete basement the anchor bolts must have a design tension capacity $F_{b,t,Rd}$ given in Annex C.

The post bases are for use in timber structures subject to the service classes 1, 2 and 3 of Eurocode 5 and for connections subject to static or quasi-static loading.

Screws made from carbon steel are used in service classes 1 and 2. For use in service class 3 screws made from stainless steel are required.

The scope of the post bases regarding resistance to corrosion shall be defined according to national provisions that apply at the installation site considering environmental conditions and in conjunction with the admissible service conditions according to EN 1995-1-1 and the admissible corrosivity category as described and defined in EN ISO 12944-2

Assumed working life

The assumed intended working life of the connectors for the intended use is 50 years, provided that they are subject to appropriate use and maintenance.

The information on the working life should not be regarded as a guarantee provided by the manufacturer or ETA Denmark. An "assumed intended working life" means that it is expected that, when this working life has elapsed, the real working life may be, in normal use conditions, considerably longer without major degradation affecting the essential requirements.

3 Performance of the product and references to the methods used for its assessment

Characteristic	Assessment of characteristic
3.1 Mechanical resistance and stability (BWR 1)*)	
Characteristic load-carrying capacity	See Annex D
Stiffness	No performance determined
Ductility in cyclic testing	No performance determined
3.2 Safety in case of fire (BWR 2)	
Reaction to fire	The post bases are made from steel classified as Euroclass A1 in accordance with EN 1350-1 and EC decision 96/603/EC, amended by EC Decision 2000/605/EC
3.3 Hygiene, health and the environment (BWR 3)	
Influence on air quality	No dangerous materials
3.7 Sustainable use of natural resources (BWR 7)	No Performance Determined
3.8 General aspects related to the performance of the product	The post bases have been assessed as having satisfactory durability and serviceability when used in timber structures using the timber species described in Eurocode 5 and subject to the conditions defined by service class 1, 2 and 3
Identification	See Annex A.

*) See additional information in section 3.9 – 3.12.

In addition to the specific clauses relating to dangerous substances contained in this European technical Assessment, there may be other requirements applicable to the products falling within its scope (e.g. transposed European legislation and national laws, regulations and administrative provisions). In order to meet the provisions of the Construction Products Regulation, these requirements need also to be complied with, when and where they apply.

3.9 Methods of verification

Safety principles and partial factors

The characteristic load-carrying capacities are based on the characteristic values of the connections with metal fasteners, the steel plates and the timber post.

In the case of timber failure or failure of the metal fasteners, the design values shall be calculated according to EN 1995-1-1 by dividing the characteristic values of the load-carrying capacities by different partial factors for the strength properties, and in addition multiplied with the coefficient k_{mod} .

In the case of steel failure, the design value shall be calculated according to EN 1993-1-1 by reducing the characteristic values of the load-carrying capacity with different partial factors.

The design value of the load-carrying capacity is the smaller value of all load-carrying capacities:

$$F_{\text{Rd}} = \min \left\{ \frac{k_{\text{mod}} \cdot F_{\text{Rk,T}}}{\gamma_{\text{M,T}}}, \frac{F_{\text{Rk,S}}}{\gamma_{\text{Mi,S}}} \right\}$$

Therefore, for timber failure or failure of the metal fasteners the load duration class and the service class are included. The different partial factors γ_{M} for steel or timber failure, respectively, are also correctly taken into account.

3.10 Mechanical resistance and stability

See Annex D for the characteristic load-carrying capacity in the different directions: tension load N_{t} , compression load N_{c} and lateral load V . No distinction between the directions of V_1 and V_2 is necessary. Using the load-carrying capacities of the post bases, the specifications in Annex B must be fulfilled. The end grain of the timber post must in general be plane on the base plate of the post base.

The characteristic capacities of the post bases are determined by calculation according to Eurocode 3 and Eurocode 5. They should be used for designs in accordance with Eurocode 3 and Eurocode 5 or a similar national code.

No performance has been determined in relation to ductility of a joint under cyclic testing. The contribution to the performance of structures in seismic zones, therefore, has not been assessed.

No performance has been determined in relation to the joint's stiffness properties - to be used for the analysis of the serviceability limit state.

For the clamped post bases Vario B 450, Vario K1 B 450, Vario PS B 450 and Royal PS B 600 the anchorage

capacities of the post bases in the concrete foundation of minimum strength class C20/25 have been determined and are included in Annex D.

For the other types of post bases no performance has been determined in relation to the anchorage of the post bases in the foundation. It must be checked by the designer of the structure to ensure it is not less than the post base capacity and, if necessary, the post base capacity reduced accordingly.

The lever arms e for the lateral loads V are given in Annex B. Taking into account these lever arms the anchor bolts must have a design tension capacity $F_{\text{b,t,Rd}}$ given in Annex C.

3.11 Aspects related to the performance of the product

Corrosion protection in service class 1, 2 and 3.

the post bases are produced of steel grade S235JR according to EN 10025-2 with minimum characteristic yield strength of $R_{\text{eH}} = 235 \text{ N/mm}^2$ and a minimum characteristic tensile strength of $R_{\text{m}} = 360 \text{ N/mm}^2$. The threaded rods correspond to property class 4.6 according to EN 1993-1-8

3.12 General aspects related to the use of the product

MERK Timber post bases are manufactured in accordance with the provisions of this European Technical Assessment using the manufacturing processes as identified in the inspection of the plant by the notified inspection body and laid down in the technical documentation.

The following provisions concerning product performance apply:

The timber post

- shall be restrained against rotation, and supported at the lower and upper end
- shall be of solid timber of minimum strength class C24 according to EN 338:2003-09 or glued laminated timber of minimum strength class GL24h according to EN 14080,
- shall be free from wane in the post base,
- must fulfil the requirements regarding minimum dimensions (see Annex B),
- end grain must in general be plane on the base plate of the post base.

The post base shall be installed centrally in the cross-section of the timber column.

The actual end bearing capacity of the timber member to be used in conjunction with the post base is checked by the designer of the structure to ensure it is not less than the post base capacity and, if necessary, the post base capacity reduced accordingly.

There are no specific requirements relating to preparation of the timber members.

The anchorage of the clamped post bases (types with supplement "B") in the foundation is covered by this ETA. The concrete shall be in accordance with strength class C20/25 according to Eurocode 2-1-1 or better.

The anchorage of all the other types of post bases in the foundation is not part of this ETA. It must be checked by the designer of the structure to ensure it is not less than the post base capacity and, if necessary, the post base capacity reduced accordingly. The minimum anchorage capacities are given in Annex C.

4 Assessment and verification of constancy of performance (AVCP)

4.1 AVCP system

According to the decision 97/638/EC of the European Commission¹, as amended, the system(s) of assessment and verification of constancy of performance (see Annex V to Regulation (EU) No 305/2011) is 2+.

5 Technical details necessary for the implementation of the AVCP system, as foreseen in the applicable EAD

Technical details necessary for the implementation of the AVCP system are laid down in the control plan deposited at ETA-Danmark

Issued in Charlottenlund on 2014-06-02 by

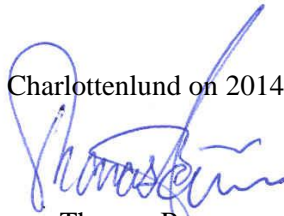

Thomas Bruun
Managing Director, ETA-Danmark

Annex A
Product details and definitions

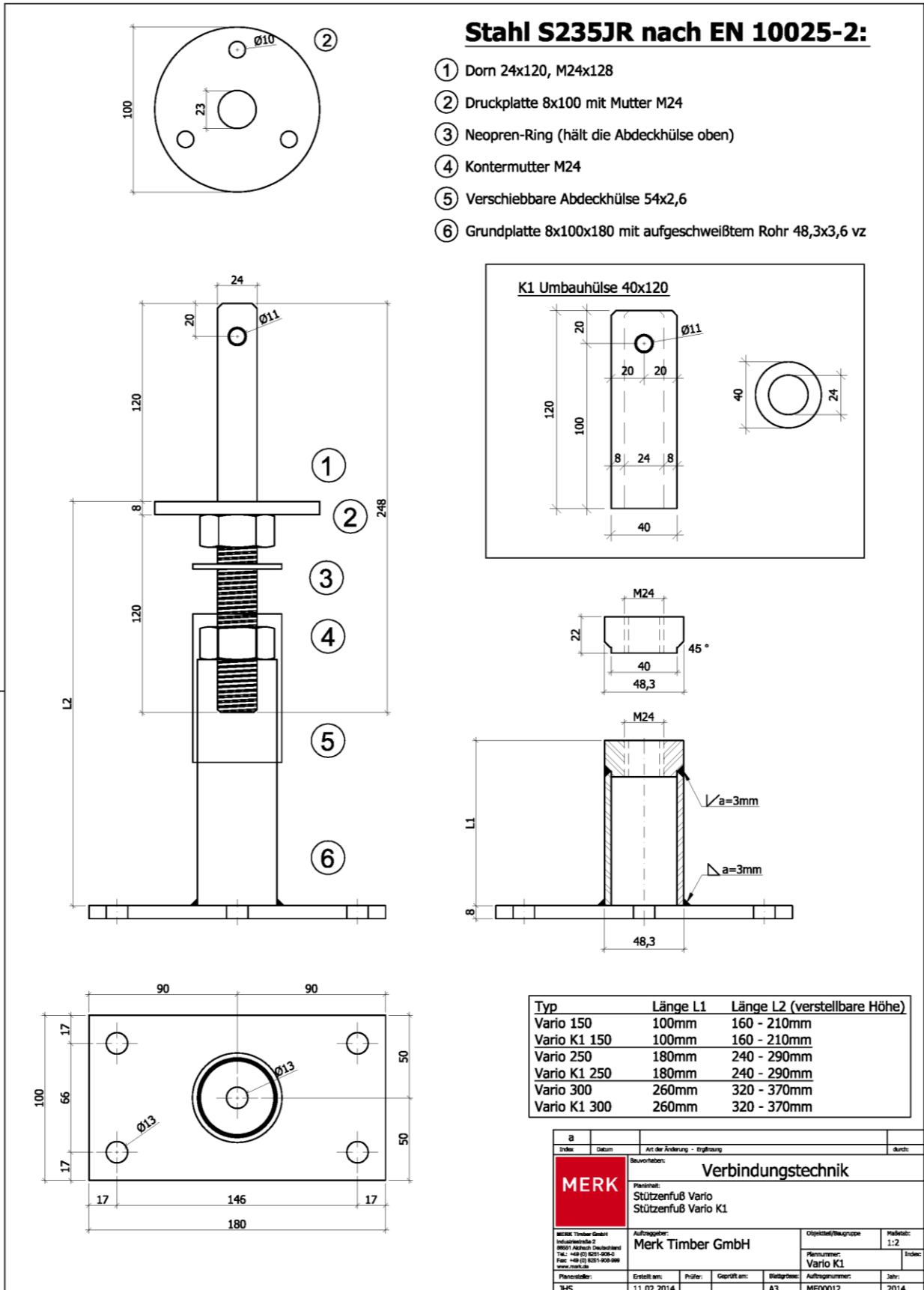

Post base Type Vario and Vario K1

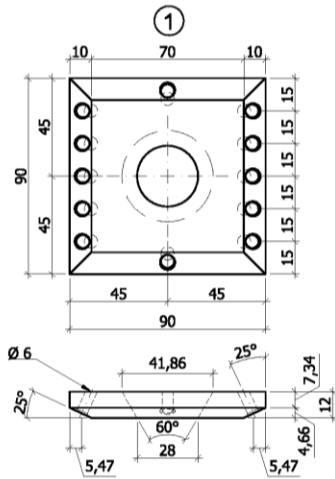

Stahl S235JR nach EN 10025-2:

- ① Drehbare Druckplatte 90x90x12 mit Schrägbohrungen
- ② Mutter M24 mit Scheibe Ø 50x3,5
- ③ Neopren-Ring (hält die Abdeckhülse oben)
- ④ Kontermutter M24
- ⑤ Gewindebolzen mit Senkkopf M24x160 4.6 nach EN 1993-1-8
- ⑥ Verschiebbare Abdeckhülse 54x2,6
- ⑦ Grundplatte 8x100x180 mit aufgeschweißtem Rohr 48,3x3,6 vz

Montagematerial:

12 Stück Holzbauschrauben 5 x 70mm Vollgewinde bauaufsichtlich zugelassen nach ETA-12/0114

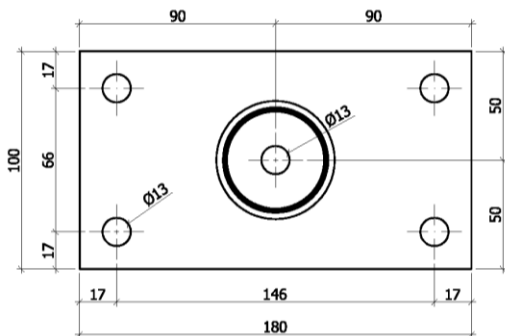
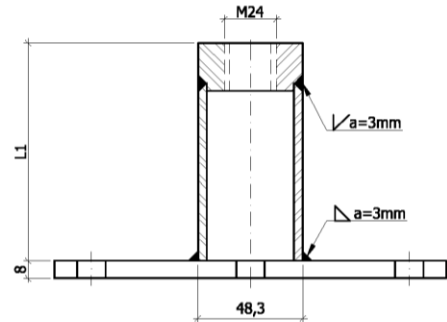
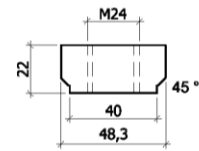
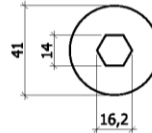
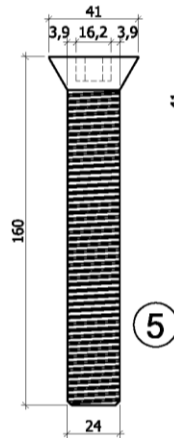
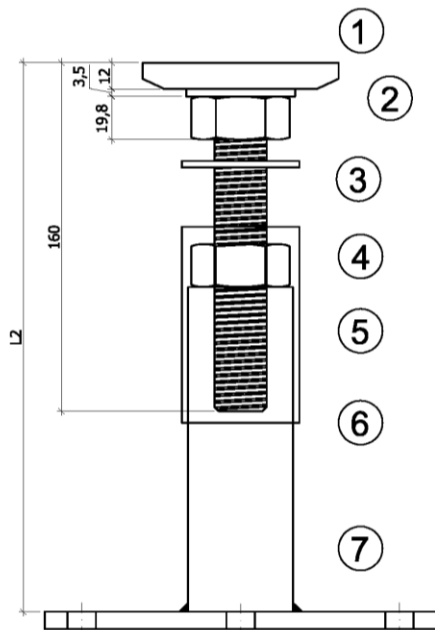

Typ	Länge L1	Länge L2 (verstellbare Höhe)
Vario PS 150	100mm	160 - 210mm
Vario PS 250	180mm	240 - 290mm
Vario PS 300	260mm	320 - 370mm

<table border="1"> <tr> <td>Index</td> <td>Datum</td> <td>Art der Änderung - Erläuterung</td> <td>Gezeichnet</td> </tr> </table>	Index	Datum	Art der Änderung - Erläuterung	Gezeichnet	Bauvorhaben: Verbindungstechnik Fachheit: Stützenfuß Vario PS
Index	Datum	Art der Änderung - Erläuterung	Gezeichnet		
MERK Merk Timber GmbH Industriestrasse 2 22009 Alphen (Deutschland) Tel.: +49 (0) 4201-908-0 Fax: +49 (0) 4201-908-999 www.merk.de	Auftraggeber: Merk Timber GmbH Objekt/Objektgruppe: Vario PS Maßstab: 1:2				
Planerstellt: JHS	Erstellt am: 11.02.2014				
Prüfer: Geprüft am: Blattgröße: A3	Auftragsnummer: ME00012 Jahr: 2014				

Post base Type Vario PS

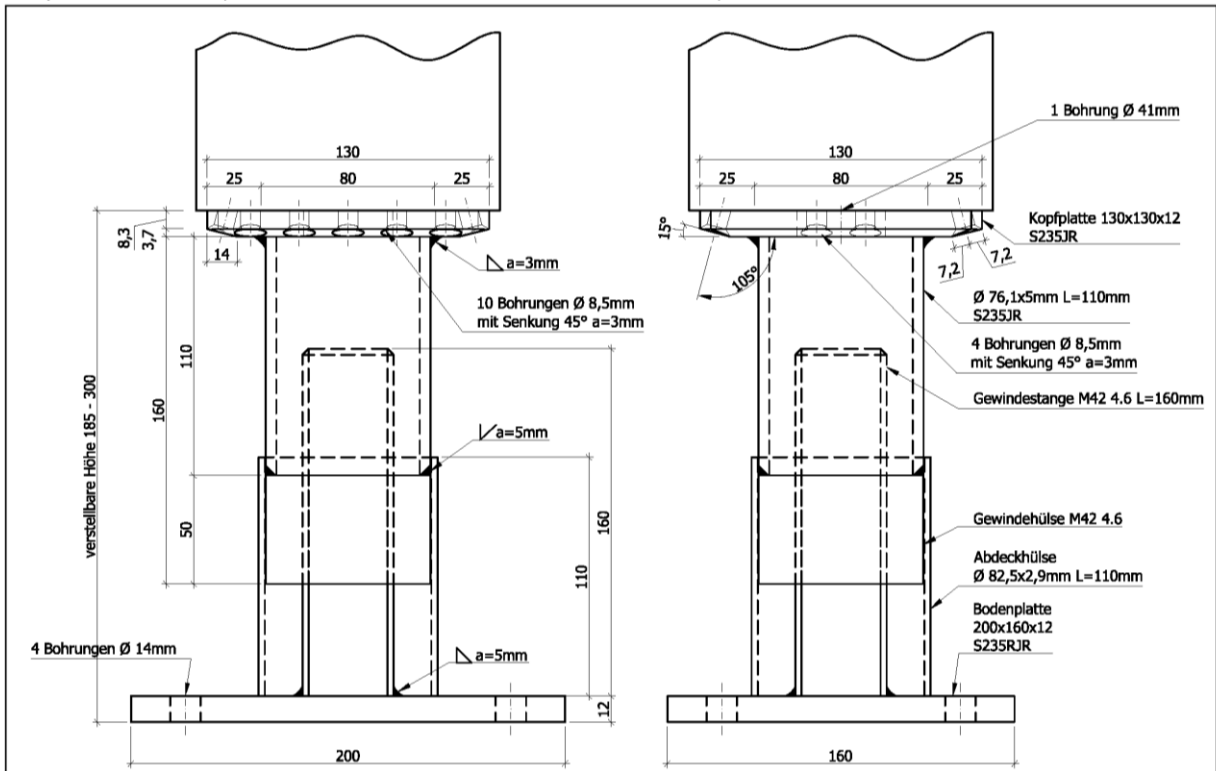

Stahl S235JR nach EN 10025-2:

- Flachstahl 130 x 130mm t=12mm
- Rundrohr \varnothing 76,1 x 5mm L=110mm
- Gewindehülse M42 4.6 L=50mm
- Gewindestange M42 4.6 L=160mm
- Abdeckhülse \varnothing 82,5 x 2,9mm L=110mm
- Flachstahl 200 x 160mm t=12mm

Montagematerial:

14 Stück Holzbauschrauben 8 x 160mm Vollgewinde bauaufsichtlich zugelassen nach ETA-12/0114

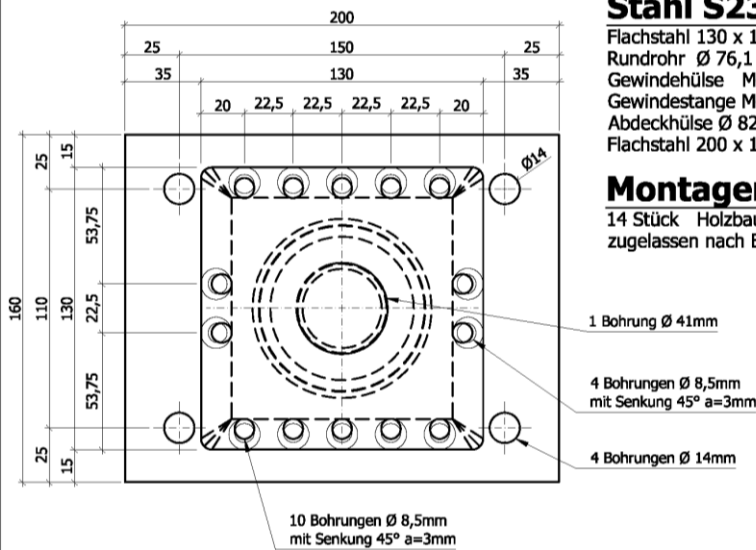

Royal PS

Höhenverstellbar 185-300mm

a	Index	Datum	Art der Änderung - Begründung	durch:
			Bauverfahren:	
			Verbindungstechnik	
			Planinhalt:	
			Stützenfuß Royal PS	
			Auftraggeber:	Objekt/Baugruppe
			Merk Timber GmbH	Merk Timber GmbH
			Plannummer:	Maßstab:
			Royal PS	1:2
			Auftragsnummer:	Index:
			Erstellt am:	Prüfer:
			11.02.2014	
			Geprüft am:	Blattgröße:
				A3
			Auftragsnummer:	Jahr:
				2014

Post base Type **Royal PS**

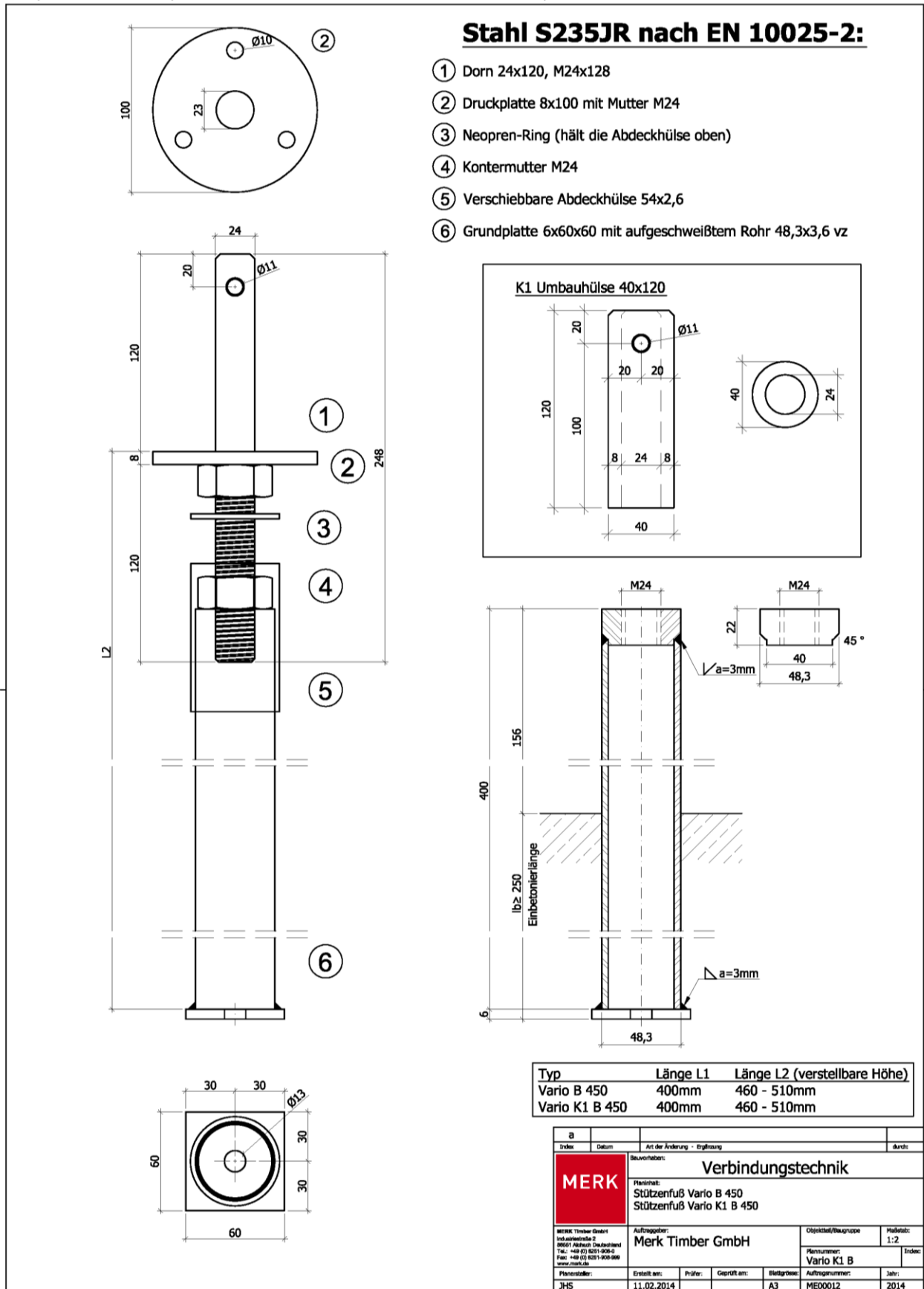

Post base Type Vario B 450 and Vario K1 B 450

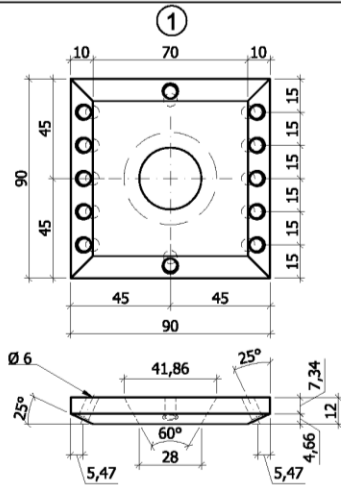

Stahl S235JR nach EN 10025-2:

- ① Drehbare Druckplatte 90x90x12 mit Schrägbohrungen
- ② Mutter M24 mit Scheibe Ø 50x3,5
- ③ Neopren-Ring (hält die Abdekhülse oben)
- ④ Kontermutter M24
- ⑤ Gewindebolzen mit Senkkopf M24x160 4.6 nach EN 1993-1-8
- ⑥ Verschiebbare Abdekhülse 54x2,6
- ⑦ Grundplatte 6x60x60 mit aufgeschweißtem Rohr 48,3x3,6 vz

Montagematerial:

12 Stück Holzbauschrauben 5 x 70mm Vollgewinde bauaufsichtlich zugelassen nach ETA-12/0114

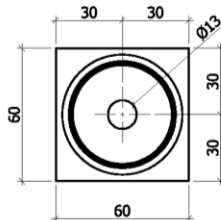
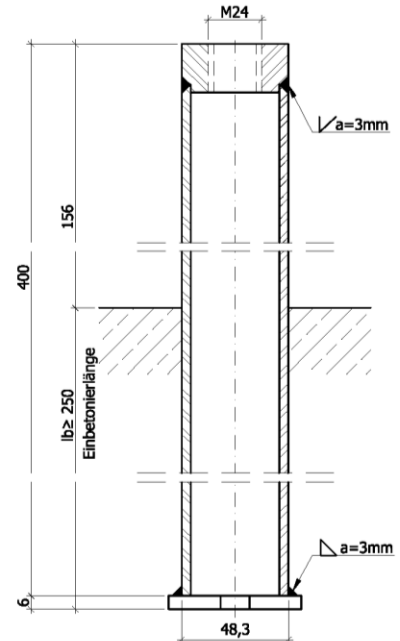
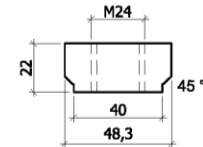
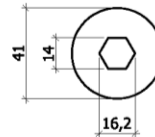
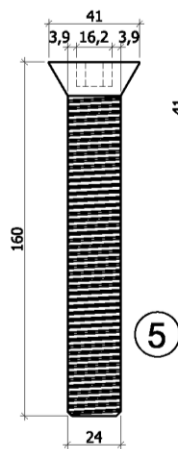
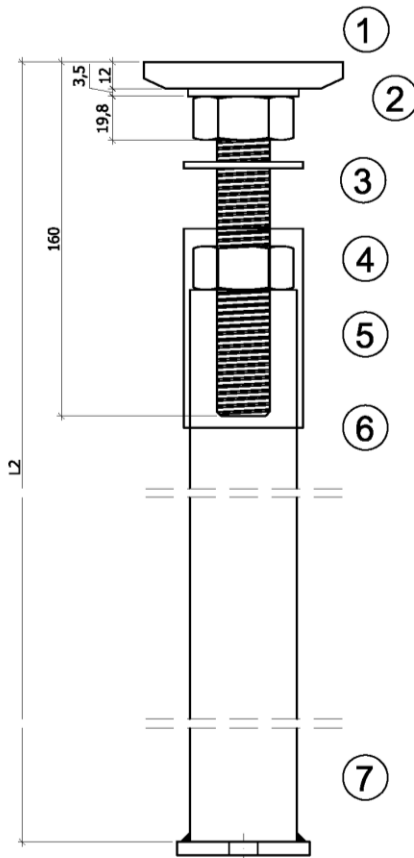

Typ	Länge L1	Länge L2 (verstellbare Höhe)
Vario PS B 450	400mm	460 - 510mm

Index	Datum	Art der Änderung - Begründung	durch
VERBUNDTECHNIK Bauverfahren: Verbindungstechnik Planname: Stützenfuß Vario PS B 450			
MERK MERK Timber GmbH Industriestrasse 2 99001 Althausen Deutschland Tel: +49 (0) 3831-93843 Fax: +49 (0) 3831-938-999 www.merk.de		Auftragsgeber: Merk Timber GmbH	Objekt/Baugruppe Vario PS B
Plansteller:	Erstellt am:	Prüfer:	Gepüft am:
JHS	11.02.2014		A3
			Blattgröße:
			A3
			Auftragsnummer:
			ME00012
			Jahr:
			2014
			Maßstab:
			1:2
			Index:

Post base Type Vario PS B 450

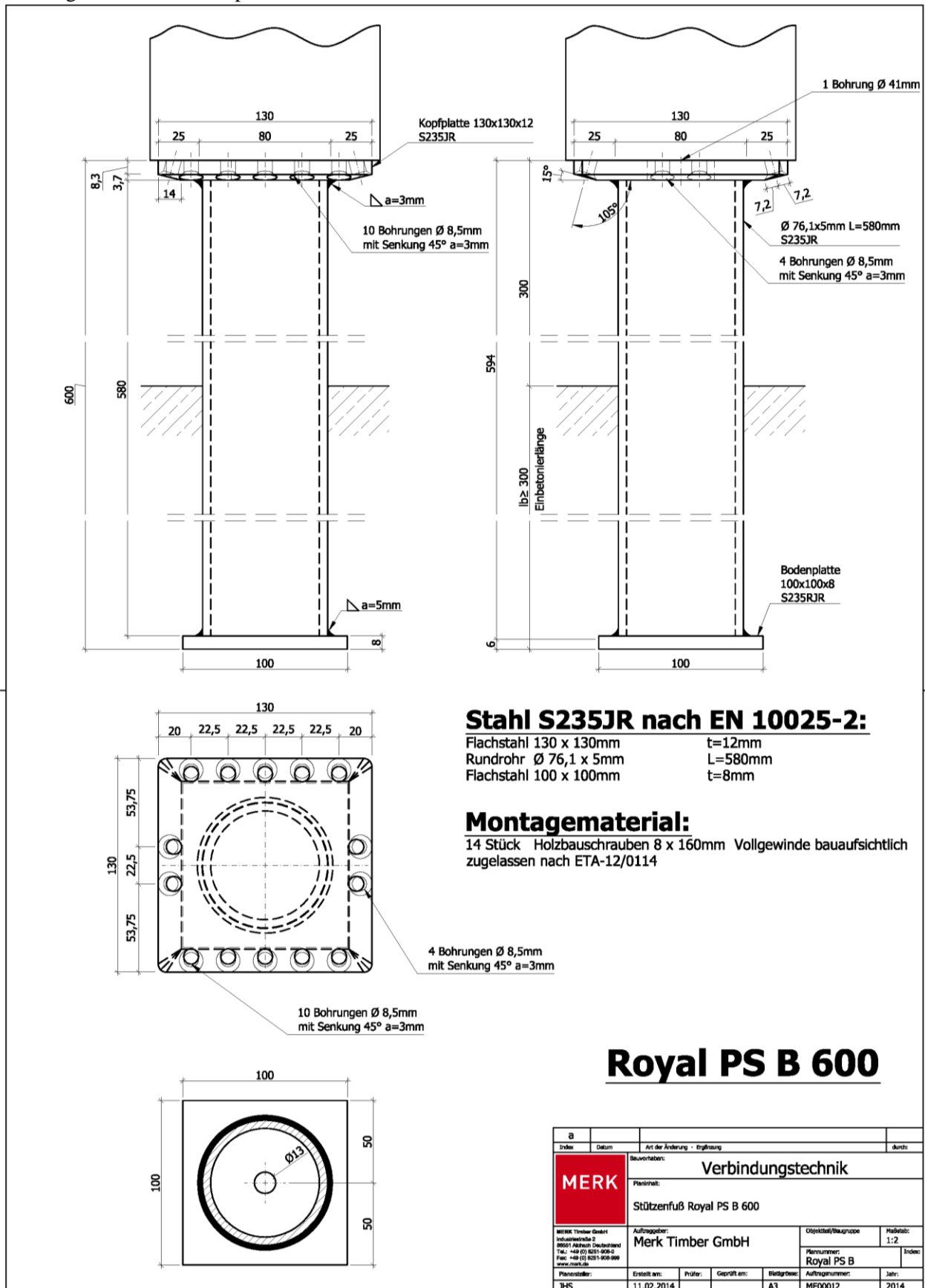

Post base Type **Royal PS B 600**

Annex B
Product specification

post base	steel – timber joint	bore hole in end grain of post [mm]	minimum post dimensions b/h [mm]	maximum distance between foundation and base plate of post [mm]	lever arm for lateral loads V [mm]
Vario 150	1 dowel Ø 10 mm	24	120/120	218	100
Vario 250				298	180
Vario 300				378	260
Vario B 450				266	-
Vario K1 150	1 dowel Ø 10 mm with 40 mm casing	40	120/120	218	100
Vario K1 250				298	180
Vario K1 300				378	260
Vario K1 B 450				266	-
Vario PS 150	12 screws 5x70 mm	-	120/120	218	100
Vario PS 250				298	180
Vario PS 300				378	260
Vario PS B 450				266	-
Royal PS	14 screws 8x160 mm	-	140/140	300	160
Royal PS B 600				300	-

Annex C
Minimum tension capacities of anchor bolts

post base	Minimum tension capacity $F_{t,bRd}$ of anchor bolts depending on the tension load $N_{t,d}$ and the shear load V_d
Vario 150	$F_{t,bRd} \geq 1,52 \cdot V_d + 0,25 \cdot N_{t,d}$
Vario 250	$F_{t,bRd} \geq 2,73 \cdot V_d + 0,25 \cdot N_{t,d}$
Vario 300	$F_{t,bRd} \geq 3,94 \cdot V_d + 0,25 \cdot N_{t,d}$
Vario B 450	-
Vario K1 150	$F_{t,bRd} \geq 1,52 \cdot V_d + 0,25 \cdot N_{t,d}$
Vario K1 250	$F_{t,bRd} \geq 2,73 \cdot V_d + 0,25 \cdot N_{t,d}$
Vario K1 300	$F_{t,bRd} \geq 3,94 \cdot V_d + 0,25 \cdot N_{t,d}$
Vario K1 B 450	-
Vario PS 150	$F_{t,bRd} \geq 1,52 \cdot V_d + 0,25 \cdot N_{t,d}$
Vario PS 250	$F_{t,bRd} \geq 2,73 \cdot V_d + 0,25 \cdot N_{t,d}$
Vario PS 300	$F_{t,bRd} \geq 3,94 \cdot V_d + 0,25 \cdot N_{t,d}$
Vario PS B 450	-
Royal PS	$F_{t,bRd} \geq 1,45 \cdot V_d + 0,25 \cdot N_{t,d}$
Royal PS B 600	-

Annex D Load-carrying capacities

Definitions of forces and their directions

- N_t : Tension force
- N_c : Compression force
- V_1 : Shear force in direction 1 (perpendicular to the direction of the dowel or main line of screws resp.)
- V_2 : Shear force in direction 2 (parallel to the direction of the dowel or main line of screws resp.)

Note: No distinction between directions of V_1 and V_2 is necessary.

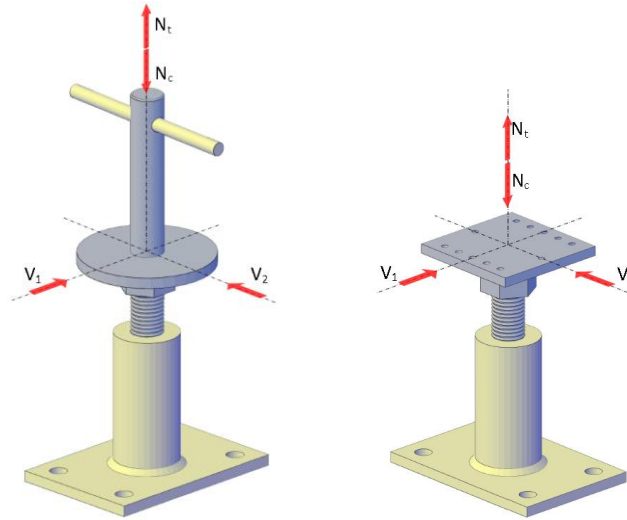

The load-carrying capacities for tensile loads ($F_{t,Rd}$), compression loads ($F_{c,Rd}$) and lateral loads ($F_{v,Rd}$) are given in the following tables.

If vertical forces (N_t , N_c) and lateral forces (V) are acting at the same time, the following inequality shall be fulfilled for each element with combined stressing:

$$\frac{N_{i,d}}{F_{i,Rd}} + \frac{V_d}{F_{v,Rd}} \leq 1$$

The results of this inequation are shown in the following diagrams.

Design load-carrying capacities

Type	Element	strength class	b/h [mm]	Tension $F_{t,Rd}$ in [kN]	Compression $F_{c,Rd}$ in [kN]	Shear $F_{v,Rd}$ in [kN]
Vario	dowel	C 24	120/120	$k_{mod} \cdot 4,9$	-	$k_{mod} \cdot 1,95$
			$\geq 160/160$	$k_{mod} \cdot 5,9$	-	$k_{mod} \cdot 2,35$
		GL 24h	120/120	$k_{mod} \cdot 5,2$	-	$k_{mod} \cdot 2,10$
			$\geq 160/160$	$k_{mod} \cdot 6,1$	-	$k_{mod} \cdot 2,45$
	head plate			-	20,7	2,6

Type	Element	strength class	b/h [mm]	Tension $F_{t,Rd}$ in [kN]	Compression $F_{c,Rd}$ in [kN]	Shear $F_{v,Rd}$ in [kN]
Vario K1	dowel	C 24	120/120	$k_{mod} \cdot 4,4$	-	$k_{mod} \cdot 1,75$
			$\geq 160/160$	$k_{mod} \cdot 5,7$	-	$k_{mod} \cdot 2,25$
		GL 24h	120/120	$k_{mod} \cdot 4,7$	-	$k_{mod} \cdot 1,85$
			$\geq 160/160$	$k_{mod} \cdot 6,1$	-	$k_{mod} \cdot 2,45$
	head plate			-	20,7	2,6

Type	Element		b/h [mm]	Tension $F_{t,Rd}$ in [kN]	Compression $F_{c,Rd}$ in [kN]	Shear $F_{v,Rd}$ in [kN]
Vario PS	timber tension perp.	C 24	120/120	$k_{mod} \cdot 7,5$	-	-
			$\geq 160/160$	$k_{mod} \cdot 9,5$	-	-
		GL 24h	120/120	$k_{mod} \cdot 12,5$	-	-
			$\geq 160/160$	$k_{mod} \cdot 15,8$	-	-
	screws	C 24		$k_{mod} \cdot 22,3$	-	$k_{mod} \cdot 6,1$ $k_{mod} \cdot 5,8$ ¹⁾
		GL 24h		$k_{mod} \cdot 23,8$		$k_{mod} \cdot 6,4$ $k_{mod} \cdot 6,1$ ¹⁾
	compression timber - head plate			-	$k_{mod} \cdot 103,0$	-
	base plate			10,3	-	2,9
	countersunk rod			60,5	44,7	3,0
	¹⁾ for screws made of stainless steel					

Type	Element		b/h [mm]	Tension $F_{t,Rd}$ in [kN]	Compression $F_{c,Rd}$ in [kN]	Shear $F_{v,Rd}$ in [kN]
Royal PS	timber tension perp.	C 24	140/140	$k_{mod} \cdot 34,7$	-	-
			$\geq 160/160$	$k_{mod} \cdot 38,6$	-	-
		GL 24h	$\geq 140/140$	$k_{mod} \cdot 57,7$	-	-
	screws	C 24		$k_{mod} \cdot 77,6$	-	$k_{mod} \cdot 18,5$ $k_{mod} \cdot 17,4$ ¹⁾
		GL 24h		$k_{mod} \cdot 82,8$	-	$k_{mod} \cdot 19,3$ $k_{mod} \cdot 18,3$ ¹⁾
	contact timber – head plate	C 24		-	$k_{mod} \cdot 238,8$	-
		GL 24h		-	$k_{mod} \cdot 272,9$	-
	contact base plate - concrete			-	128,1	-
	base plate			36,1	-	16,9
	head plate			53,7	149,9	13,8
threaded rod			322,9	168,8	12,1	
¹⁾ for screws made of stainless steel						

Design load-carrying capacities for clamped (fixed) post bases

Type	Element	strength class	b/h [mm]	Tension $F_{t,Rd}$ in [kN]	Compression $F_{c,Rd}$ in [kN]	Shear $F_{v,Rd}$ in [kN]
Vario – B 450	dowel	C 24	120/120	$k_{mod} \cdot 4,9$	-	$k_{mod} \cdot 1,95$
			$\geq 160/160$	$k_{mod} \cdot 5,9$	-	$k_{mod} \cdot 2,35$
		GL 24h	120/120	$k_{mod} \cdot 5,2$	-	$k_{mod} \cdot 2,10$
			$\geq 160/160$	$k_{mod} \cdot 6,1$	-	$k_{mod} \cdot 2,45$
	head plate			-	20,7	2,6

Type	Element	strength class	b/h [mm]	Tension $F_{t,Rd}$ in [kN]	Compression $F_{c,Rd}$ in [kN]	Shear $F_{v,Rd}$ in [kN]
Vario K1 B 450	dowel	C 24	120/120	$k_{mod} \cdot 4,4$	-	$k_{mod} \cdot 1,75$
			$\geq 160/160$	$k_{mod} \cdot 5,7$	-	$k_{mod} \cdot 2,25$
		GL 24h	120/120	$k_{mod} \cdot 4,7$	-	$k_{mod} \cdot 1,85$
			$\geq 160/160$	$k_{mod} \cdot 6,1$	-	$k_{mod} \cdot 2,45$
	head plate			-	20,7	-

Type	Element		b/h [mm]	Tension $F_{t,Rd}$ in [kN]	Compression $F_{c,Rd}$ in [kN]	Shear $F_{v,Rd}$ in [kN]
Vario PS B 450	timber tension perp.	C 24	120/120	$k_{mod} \cdot 7,5$	-	-
			$\geq 160/160$	$k_{mod} \cdot 9,5$	-	-
		GL 24h	120/120	$k_{mod} \cdot 12,5$	-	-
			$\geq 160/160$	$k_{mod} \cdot 15,8$	-	-
	screws	C 24		$k_{mod} \cdot 22,3$	-	$k_{mod} \cdot 6,1$ $k_{mod} \cdot 5,8$ ¹⁾
		GL 24h		$k_{mod} \cdot 23,8$	-	$k_{mod} \cdot 6,4$ $k_{mod} \cdot 6,1$ ¹⁾
	countersunk			60,5	44,7	3,0
¹⁾ for screws made of stainless steel						

Type	Element		b/h [mm]	Tension $F_{t,Rd}$ in [kN]	Compression $F_{c,Rd}$ in [kN]	Shear $F_{v,Rd}$ in [kN]
Royal PS B 600	timber tension perp.	C 24	140/140	$k_{mod} \cdot 34,7$	-	-
			$\geq 160/160$	$k_{mod} \cdot 38,6$	-	-
		GL 24h	$\geq 140/140$	$k_{mod} \cdot 57,7$	-	-
	screws	C 24		$k_{mod} \cdot 77,6$	-	$k_{mod} \cdot 32,9$ $k_{mod} \cdot 28,1$ ¹⁾
		GL 24h		$k_{mod} \cdot 82,8$	-	$k_{mod} \cdot 33,4$ $k_{mod} \cdot 28,5$ ¹⁾
	contact timber – head plate	C 24		-	$k_{mod} \cdot 238,8$	-
		GL 24h		-	$k_{mod} \cdot 272,9$	-
	steel tube			262,3	222,4	17,4
	contact base plate - concrete			-	129,6	-
	clamping concrete basement			-	-	17,4
	¹⁾ for screws made of stainless steel					

Design load-carrying capacities

Types Vario 150/250/300 and Vario B 450

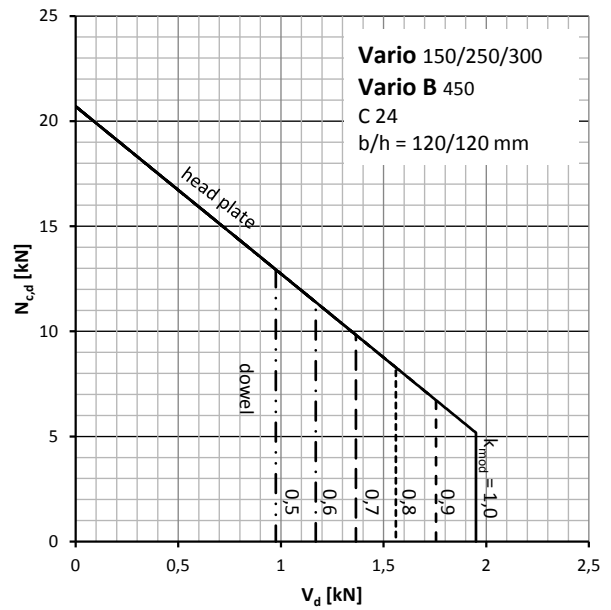
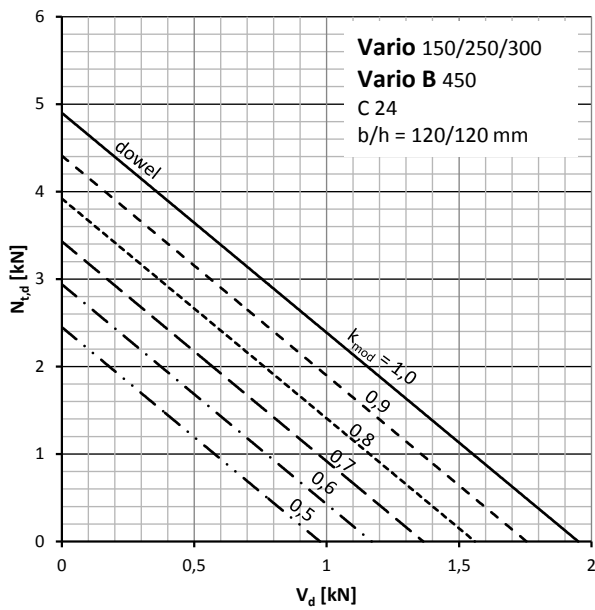

design capacities for combined loading with axial loads and shear load V_d with **C 24**

- left: with tension load $N_{t,d}$
- right: with compression loads $N_{c,d}$

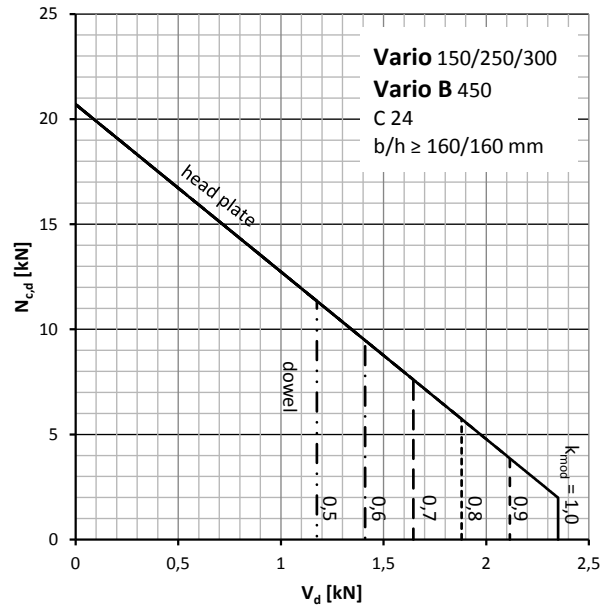
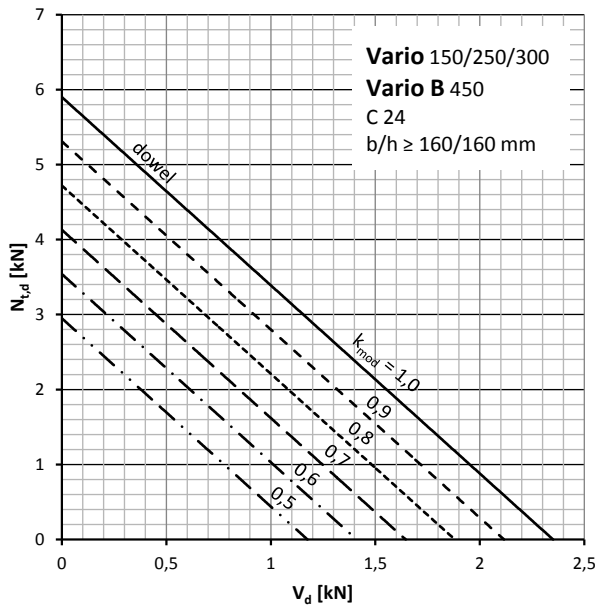

design capacities for combined loading with axial loads and shear load V_d with **C 24**

- left: with tension load $N_{t,d}$
- right: with compression loads $N_{c,d}$

Design load-carrying capacities

Types Vario 150/250/300 and Vario B 450

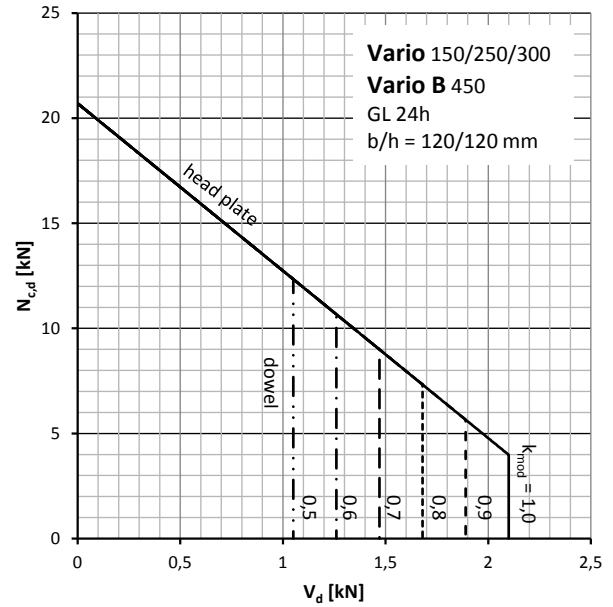
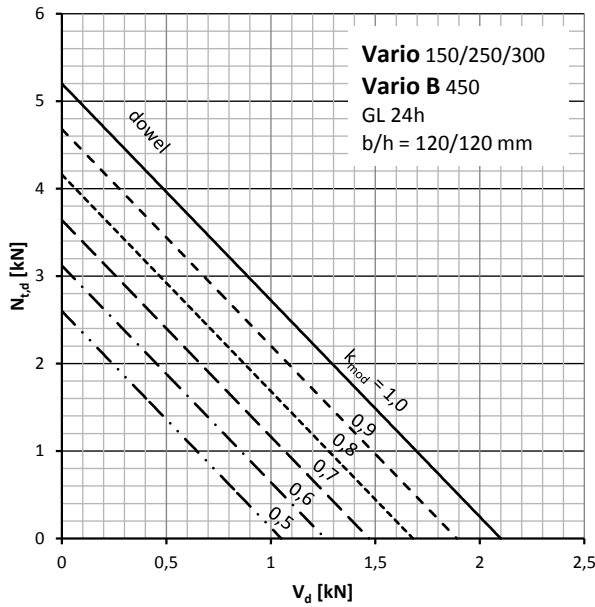

design capacities for combined loading with axial loads and shear load V_d with **GL 24h**

left: with tension load $N_{t,d}$

right: with compression loads $N_{c,d}$

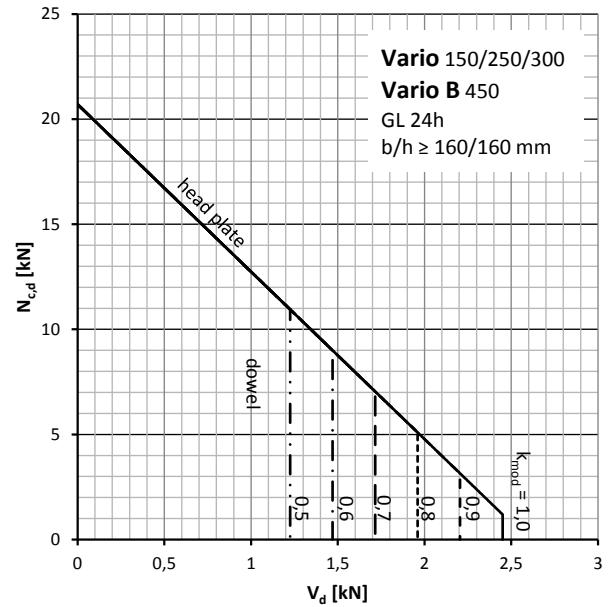
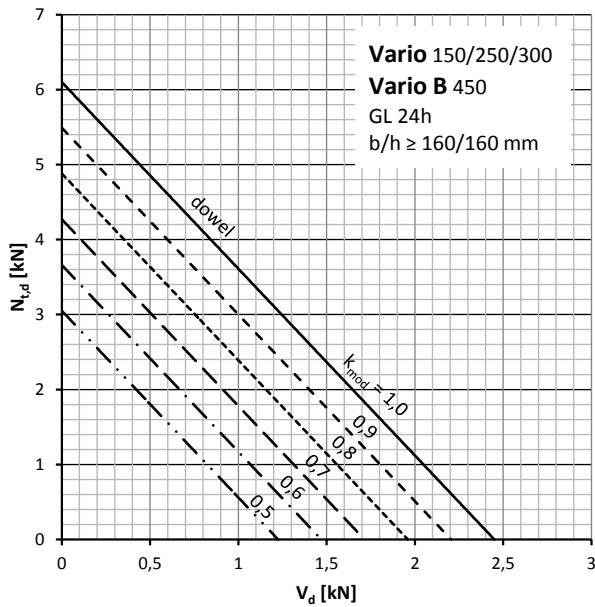

design capacities for combined loading with axial loads and shear load V_d with **GL 24h**

left: with tension load $N_{t,d}$

right: with compression loads $N_{c,d}$

Design load-carrying capacities

Types Vario K1 150/250/300 and Vario K1 B 450

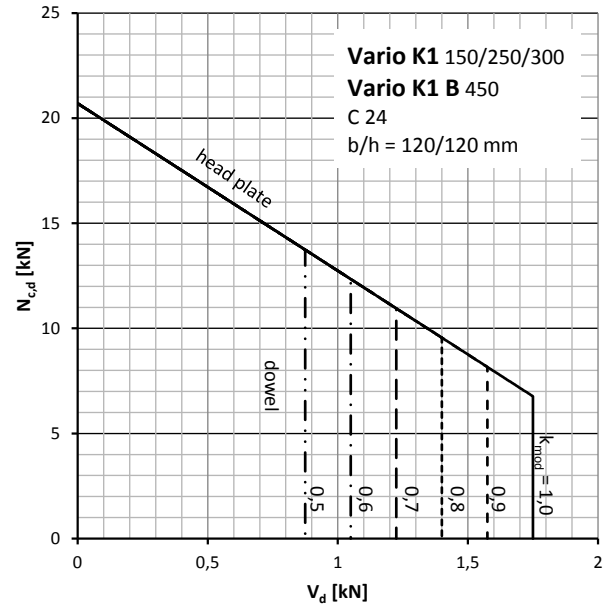
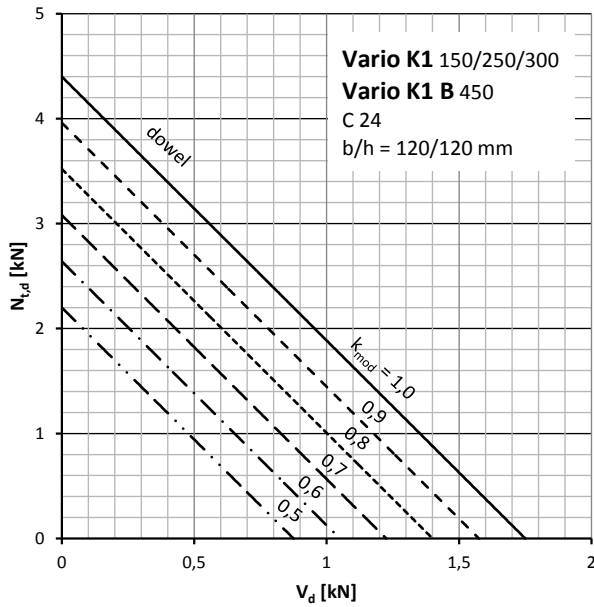

design capacities for combined loading with axial loads and shear load V_d with **C 24**

left: with tension load $N_{t,d}$

right: with compression loads $N_{c,d}$

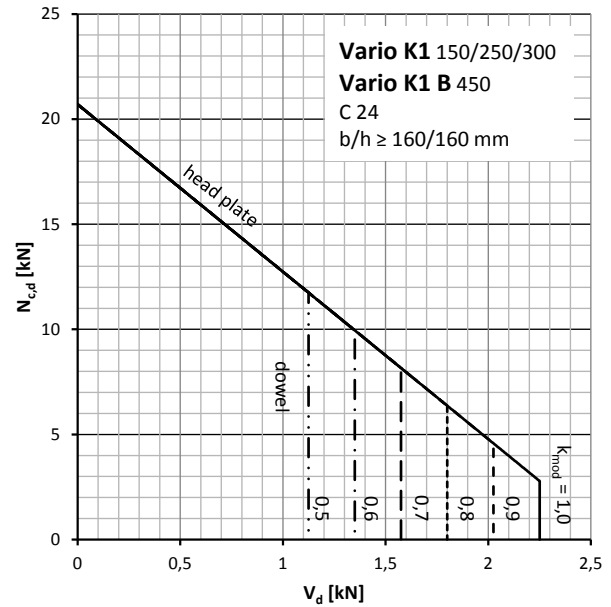
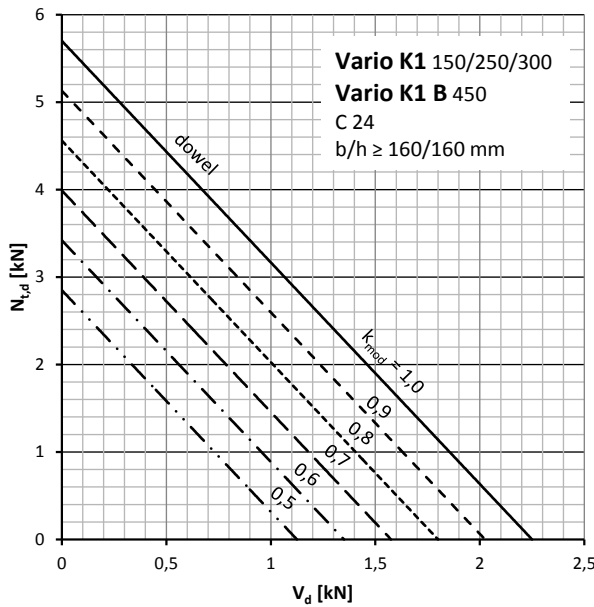

design capacities for combined loading with axial loads and shear load V_d with **C 24**

left: with tension load $N_{t,d}$

right: with compression loads $N_{c,d}$

Design load-carrying capacities

Types Vario K1 150/250/300 and Vario K1 B 450

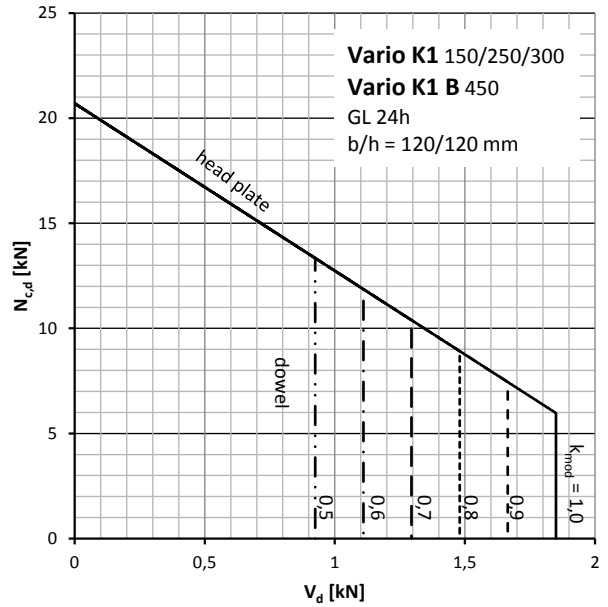
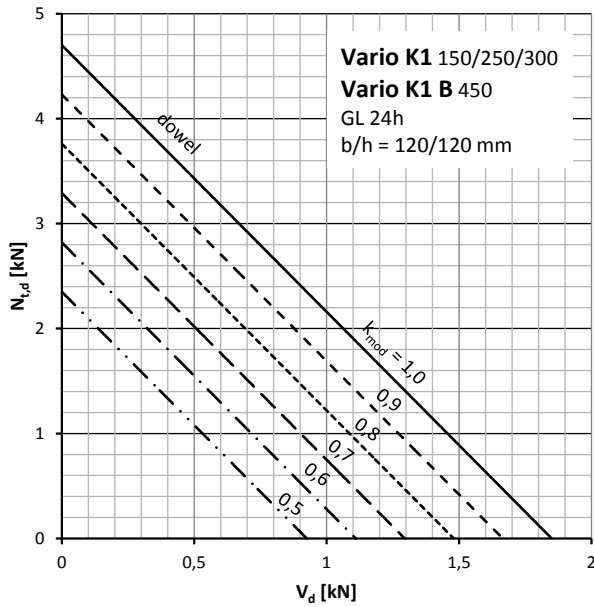

design capacities for combined loading with axial loads and shear load V_d with **GL 24h**

- left: with tension load $N_{t,d}$
- right: with compression loads $N_{c,d}$

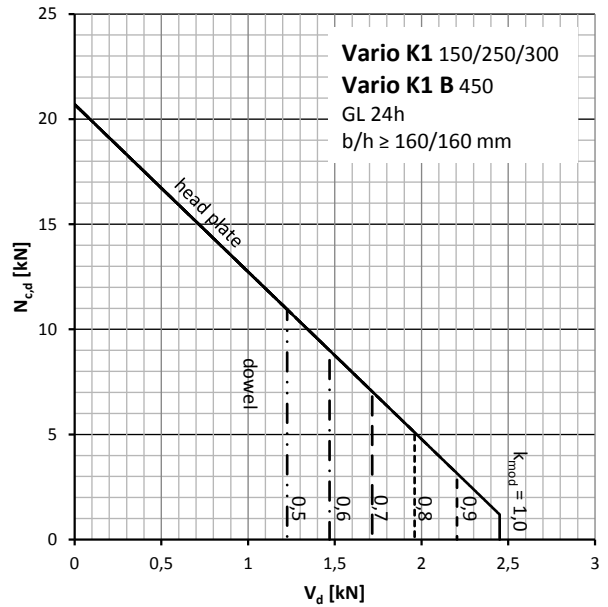
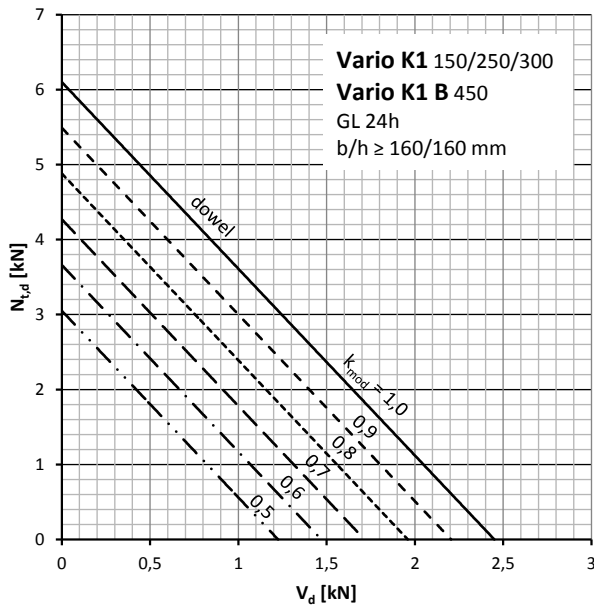

design capacities for combined loading with axial loads and shear load V_d with **GL 24h**

- left: with tension load $N_{t,d}$
- right: with compression loads $N_{c,d}$

Design load-carrying capacities

Type Vario PS 150/250/300

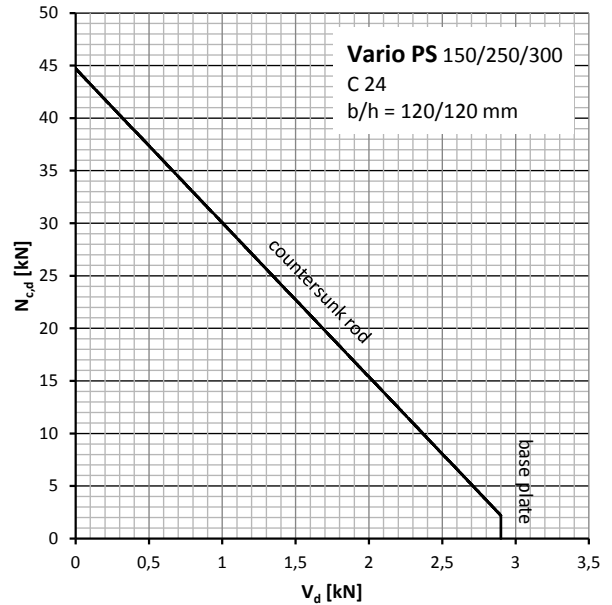
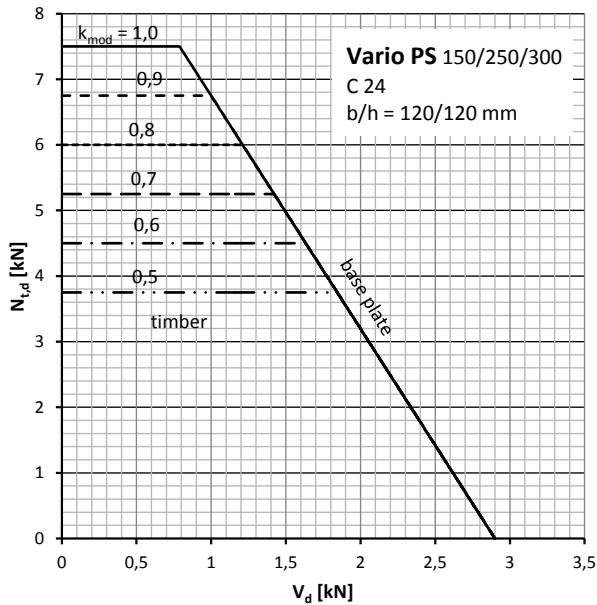

design capacities for combined loading with axial loads and shear load V_d with **C 24**

left: with tension load $N_{t,d}$

right: with compression loads $N_{c,d}$

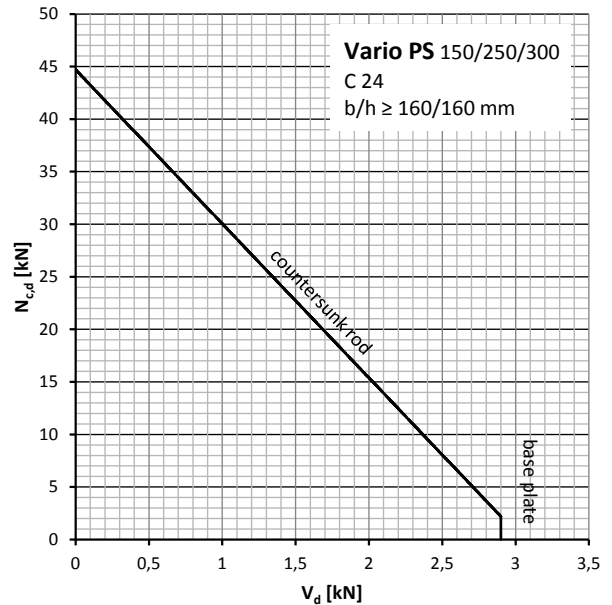
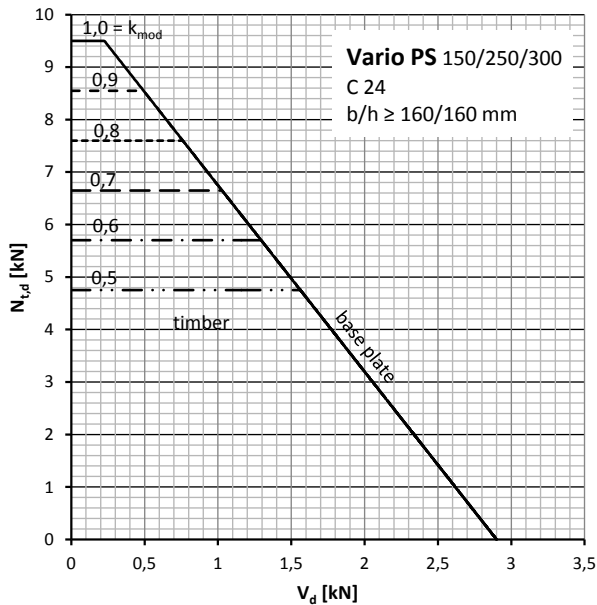

design capacities for combined loading with axial loads and shear load V_d with **C 24**

left: with tension load $N_{t,d}$

right: with compression loads $N_{c,d}$

Design load-carrying capacities

Type Vario PS 150/250/300

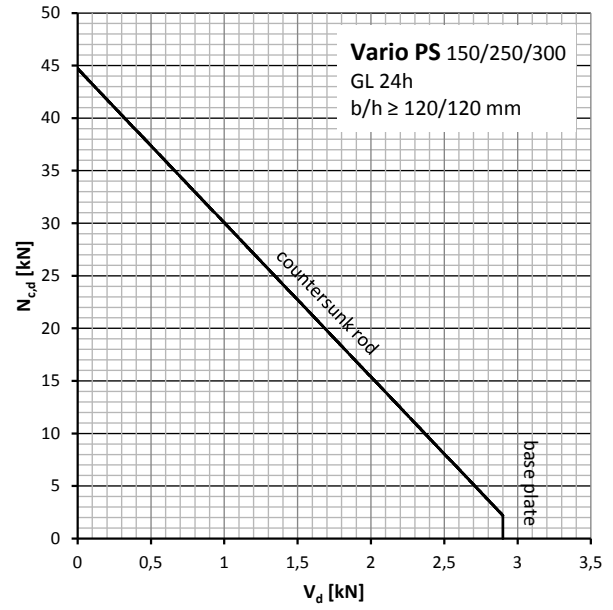
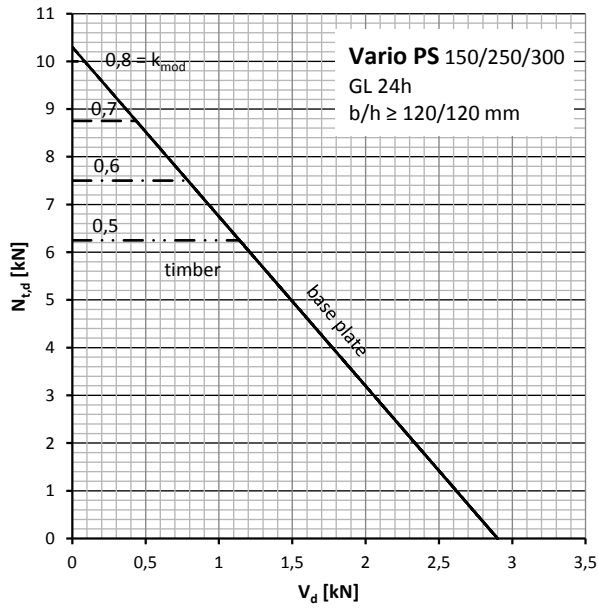

design capacities for combined loading with axial loads and shear load V_d with **GL 24h**

left: with tension load $N_{t,d}$

right: with compression loads $N_{c,d}$

Design load-carrying capacities

Type Vario PS B 450

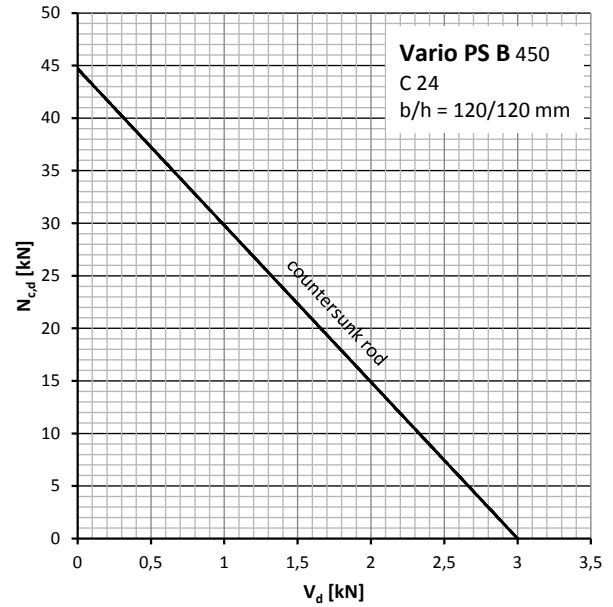
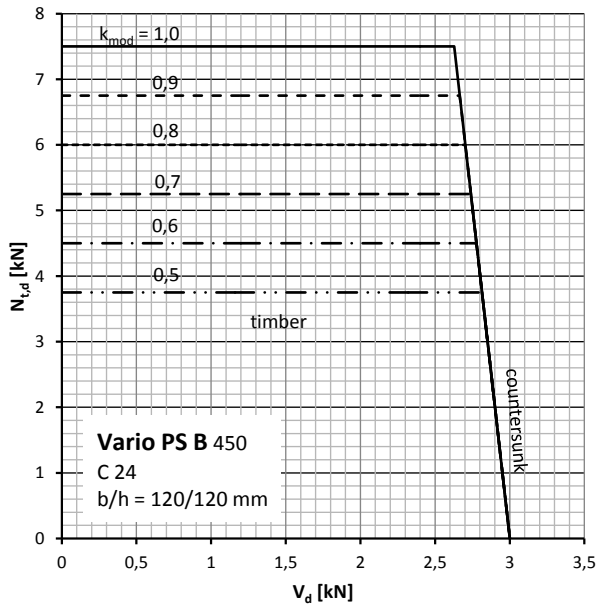

design capacities for combined loading with axial loads and shear load V_d with C 24

left: with tension load $N_{t,d}$

right: with compression loads $N_{c,d}$

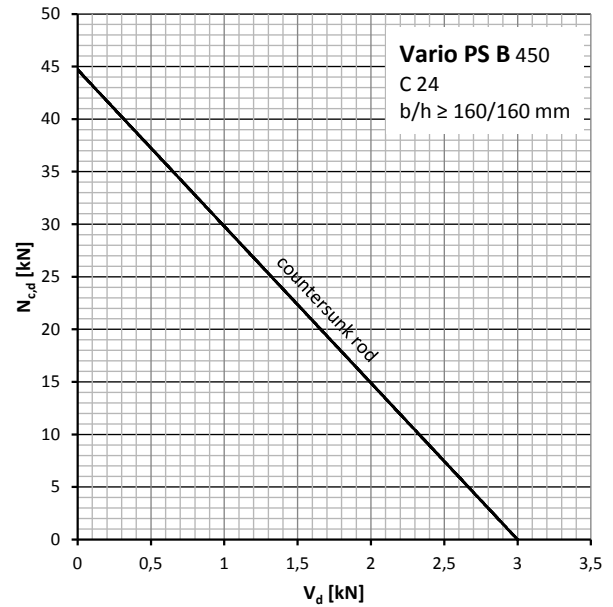
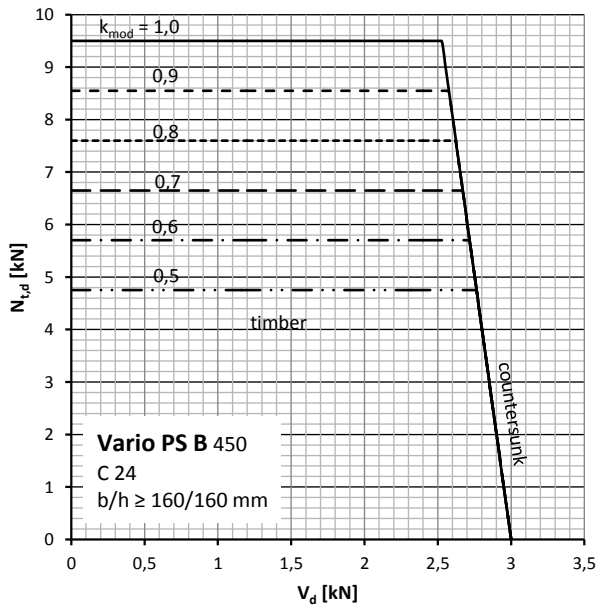

design capacities for combined loading with axial loads and shear load V_d with C 24

left: with tension load $N_{t,d}$

right: with compression loads $N_{c,d}$

Design load-carrying capacities

Type Vario PS B 450

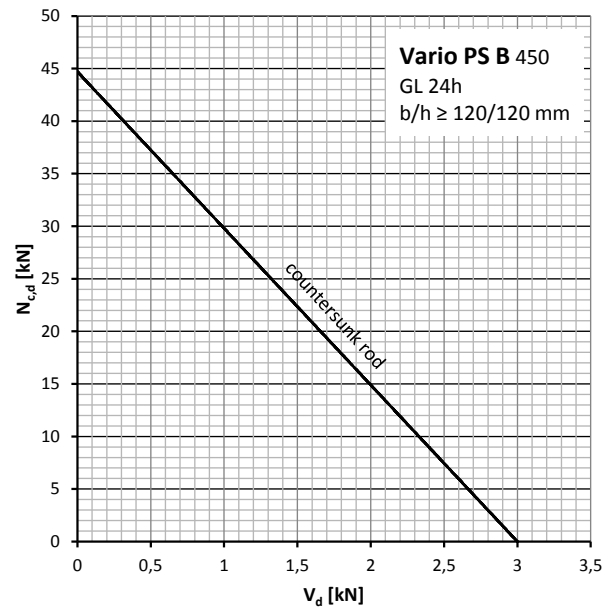
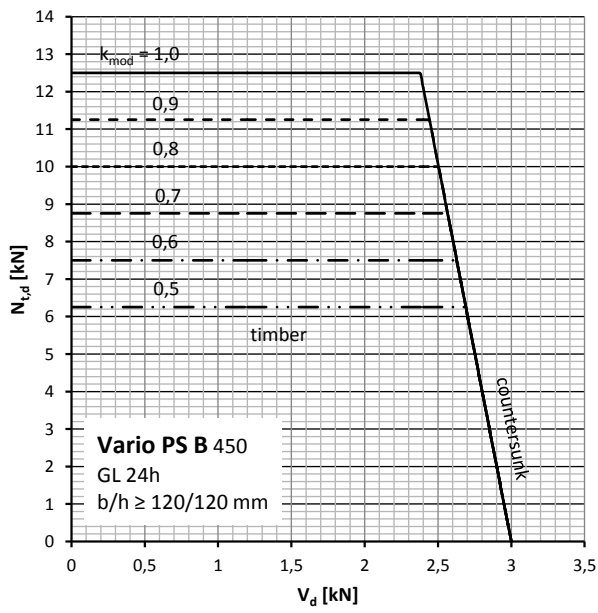

design capacities for combined loading with axial loads and shear load V_d with **GL 24h**

left: with tension load $N_{t,d}$

right: with compression loads $N_{c,d}$

Design load-carrying capacities

Type Royal PS

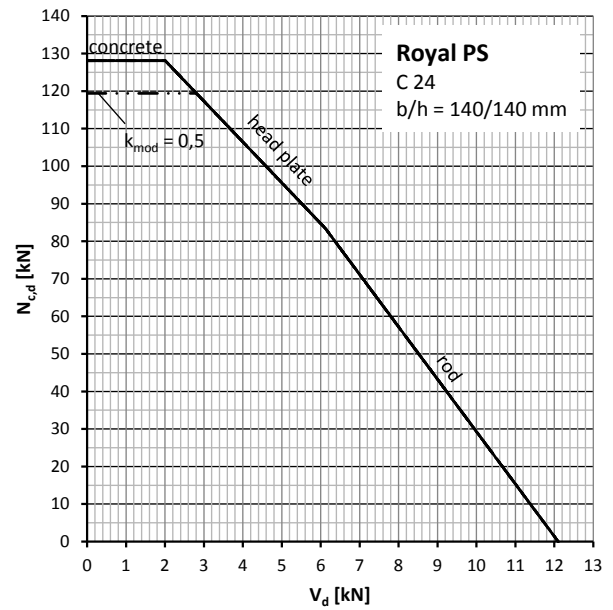
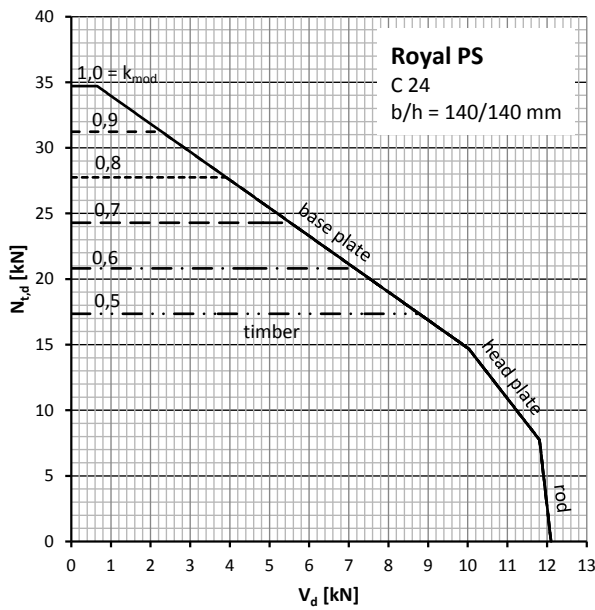

design capacities for combined loading with axial loads and shear load V_d with **C 24**

left: with tension load $N_{t,d}$

right: with compression loads $N_{c,d}$

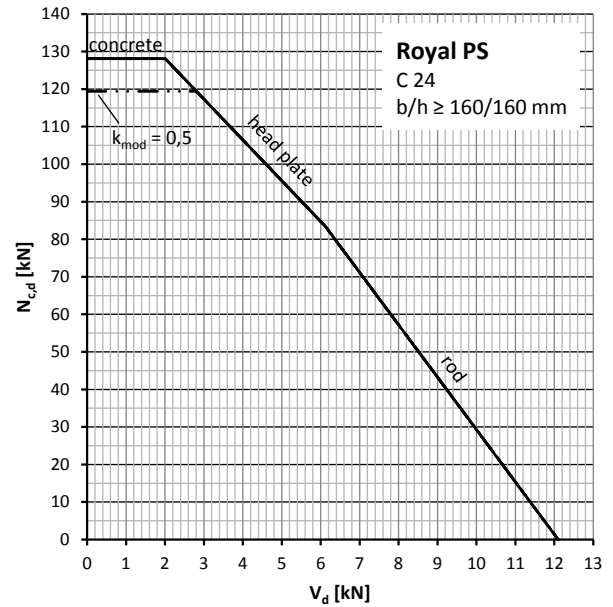
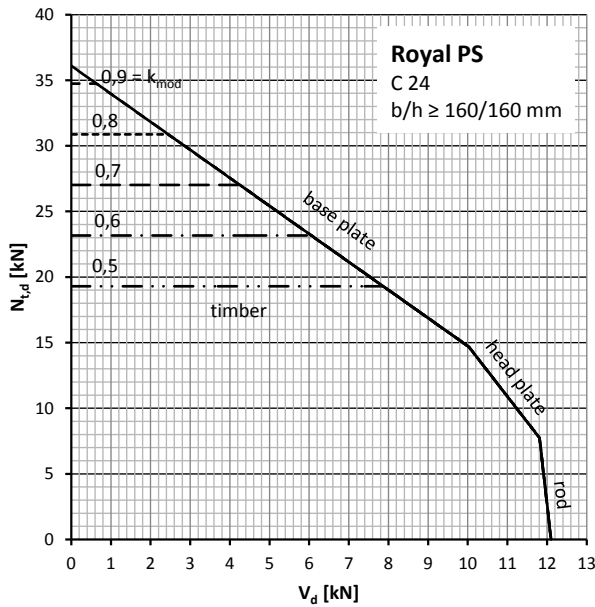

design capacities for combined loading with axial loads and shear load V_d with **C 24**

left: with tension load $N_{t,d}$

right: with compression loads $N_{c,d}$

Design load-carrying capacities

Type Royal PS

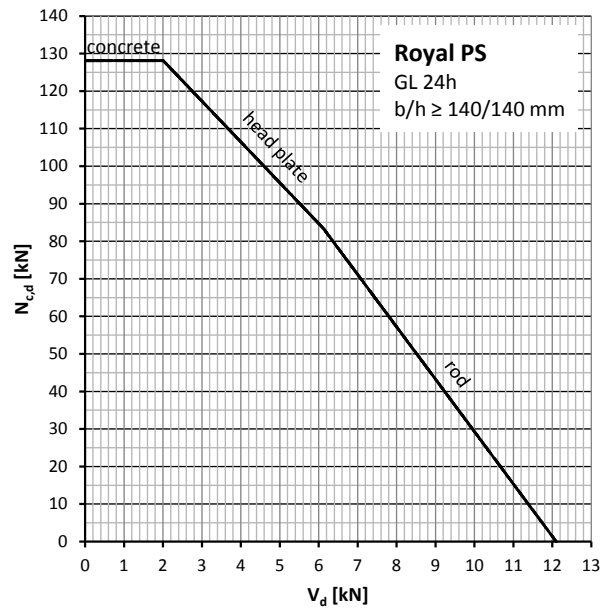
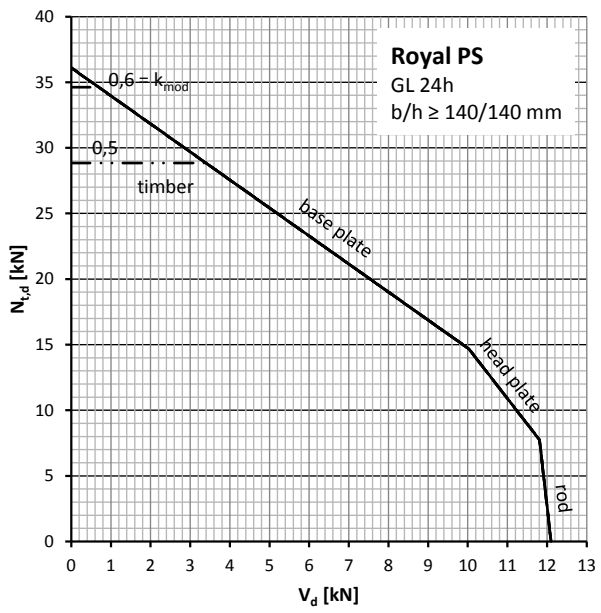

design capacities for combined loading with axial loads and shear load V_d with **GL 24h**

- left: with tension load $N_{t,d}$
- right: with compression loads $N_{c,d}$

Design load-carrying capacities

Type Royal PS B 600

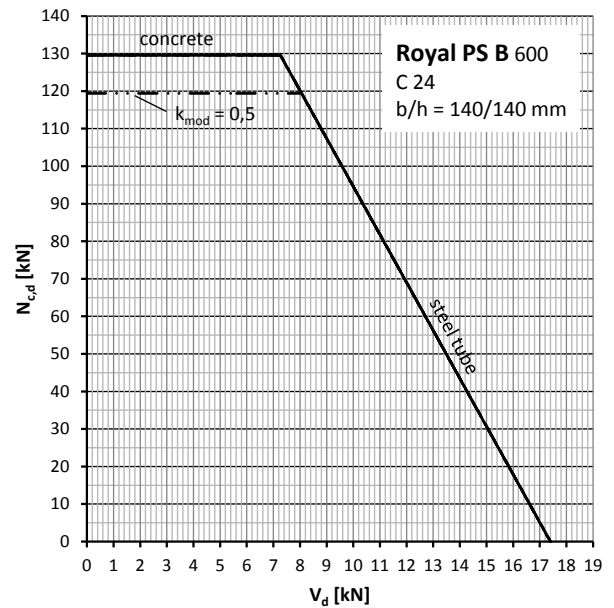
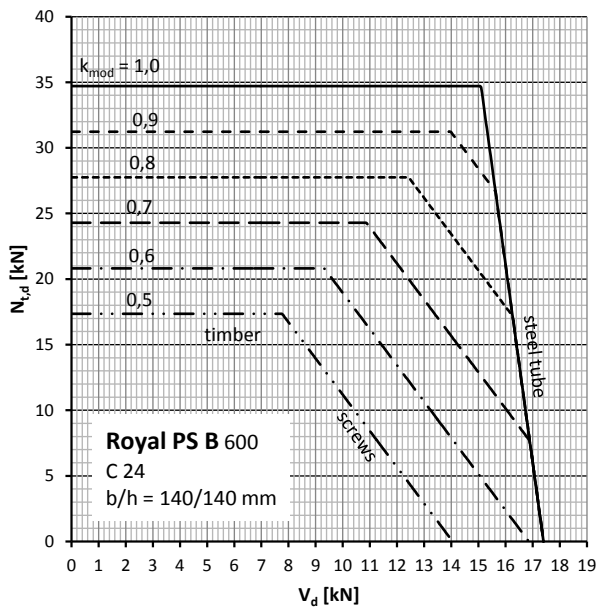

design capacities for combined loading with axial loads and shear load V_d with C 24

left: with tension load $N_{t,d}$

right: with compression loads $N_{c,d}$

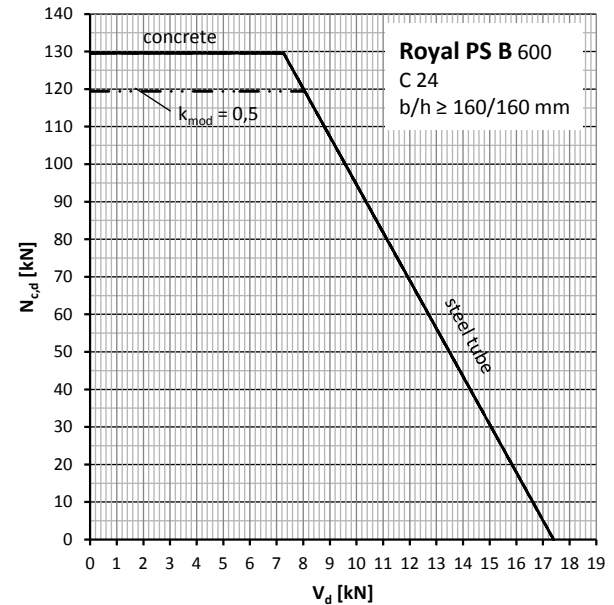
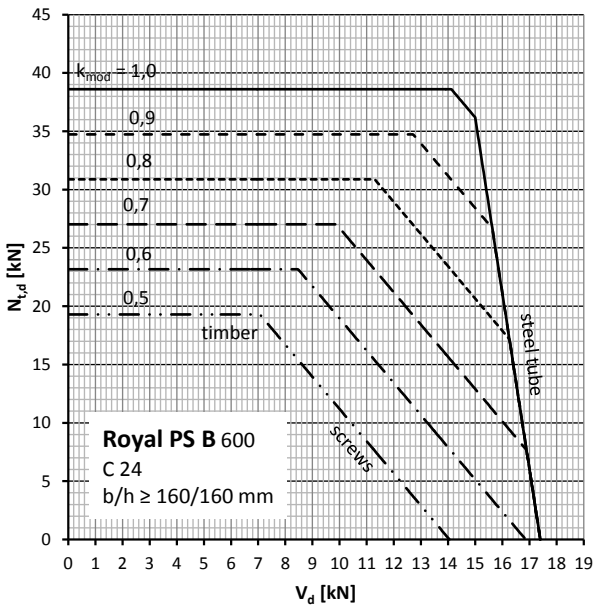

design capacities for combined loading with axial loads and shear load V_d with C 24

left: with tension load $N_{t,d}$

right: with compression loads $N_{c,d}$

Design load-carrying capacities

Type Royal PS B 600

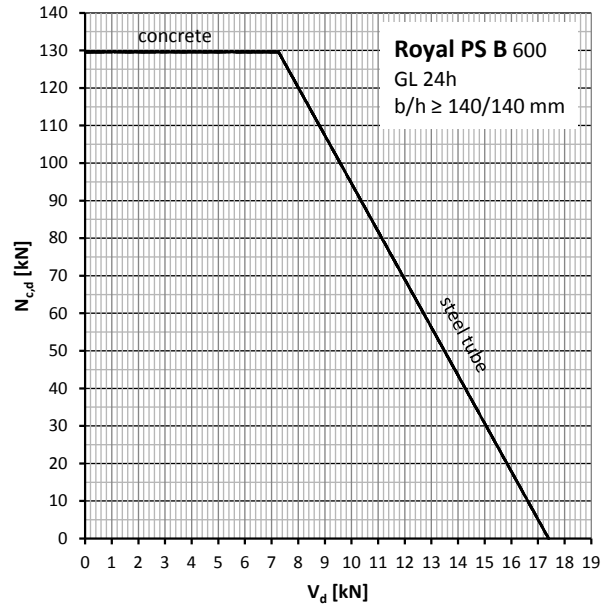
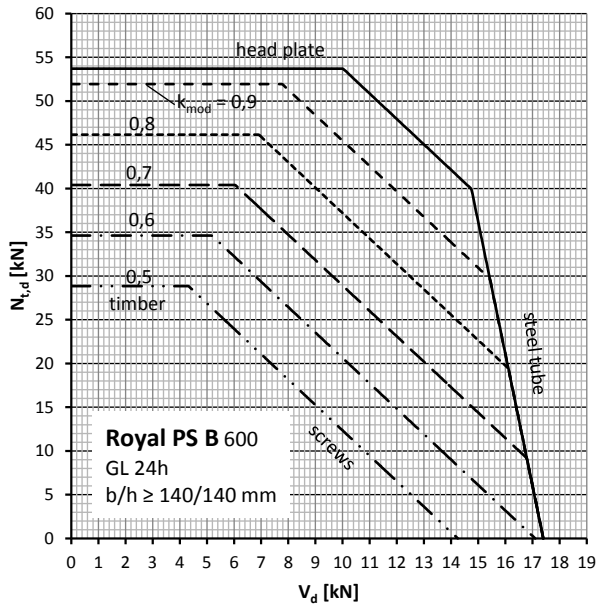

design capacities for combined loading with axial loads and shear load V_d with **GL 24h**

left: with tension load $N_{t,d}$

right: with compression loads $N_{c,d}$